

Input: 0-1 V to ± 200 VDC
Output: 0-1 V to ± 10 VDC or 0-2 mA to 4-20 mA

Wide Ranging I/O
One Minute Setup!

- One Minute Field Setup for Hundreds of I/O Ranges
- External Switches & Tables for Range Selection
- Full 2000 V Input/Output/Power Isolation
- Input and Output LoopTracker® LEDs
- Output Test Button
- Built-In Loop Power Supply for Output

Applications

- Convert, Boost, Rescale Process Signals
- One Model Covers Multiple Applications
- Interface Process Signals with Panel Meters, PLCs, Recorders, Data Acquisition, DCS, and SCADA Systems

DC Input Ranges

See table on other side for field selectable ranges
 Consult factory for special ranges
 System voltages must not exceed socket voltage rating
 Voltage: 0-1 VDC to 0-200 VDC
 Bipolar voltage: ± 1 VDC to ± 200 VDC

Input Impedance

Voltage: 1 M Ω minimum

Common Mode Rejection

120 dB minimum

LoopTracker

Variable brightness LEDs indicate I/O loop level and status

DC Output Ranges

See table on other side for field selectable ranges
 Consult factory for special ranges
 Voltage, 10 mA max.: 0-1 VDC to 0-10 VDC
 Bipolar voltage: ± 1 VDC to ± 10 VDC
 Current: 0-2 mA DC to 0-20 mA DC
 20 V compliance, 1000 Ω at 20 mA

Output Calibration

Multi-turn zero and span potentiometers for output
 $\pm 15\%$ of span adjustment range typical

Output Loop Power Supply

20 VDC nominal, regulated, 25 mA DC, max. ripple <10 mVRMS

Output Test

Sets output to test level when pressed
 Adjustable 0-100% of span
 Potentiometer factory set to approx. 50% of span

Output Ripple and Noise

Less than 10 mVRMS

Linearity

Better than $\pm 0.1\%$ of span

Ambient Temperature Range and Stability

-10°C to +60°C operating ambient
 Better than $\pm 0.02\%$ of span per °C stability, calculated, not tested

Response Time

100 milliseconds typical
 DF option: 30 milliseconds typical response time

Isolation

2000 VRMS minimum
 Full isolation: power to input, power to output, input to output

Installation Environment

IP 40, requires installation in panel or enclosure
 Use with API 008 or API 008 FS socket
 Socket mounts to 35 mm DIN rail or can be surface mounted
 UL 508C pollution degree 2 environments or better

Power

Standard: 115 VAC $\pm 10\%$, 50/60 Hz, 2.5 W max.
 P option: 85-265 VAC 50/60 Hz, 60-300 VDC, 2.5 W
 A230 option: 230 VAC $\pm 10\%$, 50/60 Hz, 2.5 W max.
 D option: 9-30 VDC, 2.5 W typical

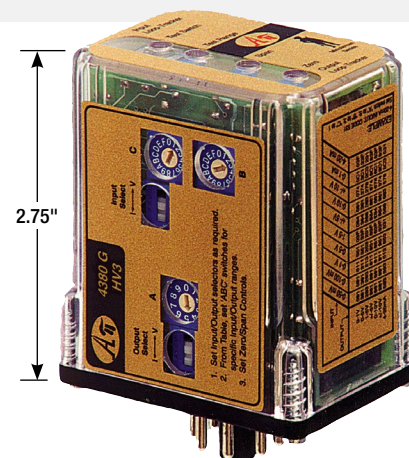
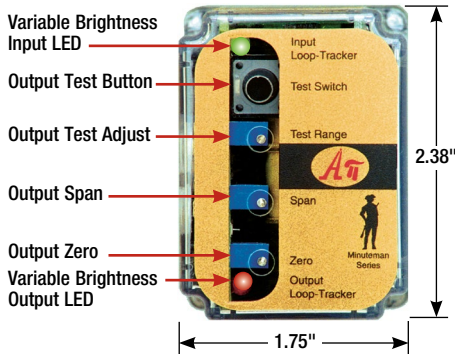

Sink or Source mA Input Hot Swappable Plug-In Design Sourcing mA Output



 115 VAC, 230 VAC models with input up to ± 150 VDC



Description

The API 4380 G HV3 accepts a DC voltage input and provides an optically isolated DC voltage or current output that is linearly related to the input. This module is unique because it is field rangeable for voltage inputs to ± 200 VDC. Typical applications include signal isolation and signal conversion.

The optical isolation between input and output makes this module useful for ground loop elimination, common mode signal rejection, and noise pickup reduction. The module power supply is isolated, resulting in full 3-way (input, output, power) isolation.

The API 4380 G HV3 input and output can be field-configured via external rotary and slide switches. Common range settings are on the module label. Most common ranges are built-in, and can be selected from the table on the module, however virtually unlimited combinations are possible. Consult the factory for assistance with special ranges.

LoopTracker

API exclusive features include two LoopTracker LEDs (green for input, red for output) that vary in intensity with changes in the process input and output signals. These provide a quick visual picture of your process loop at all times and can greatly aid in saving time during initial startup and/or troubleshooting.

Output Test



An API exclusive feature includes the Functional Test Button to provide a fixed output (independent of the input) when held depressed. The test output level can be set via a potentiometer from 0 to 100% of the output span.

The functional test button greatly aids in saving time during initial startup and/or troubleshooting.

Installation

The API 4380 G HV3 plug into an industry standard 8-pin octal socket sold separately. Sockets API 008 and finger-safe API 008 FS allow either DIN rail or panel mounting.

The plug-in design, 3-way isolation, and robust electronics allows the module to be quickly hot-swapped without removing the power or I/O signals.

| Model | Input | Output | Power |
|---------------------|---|--|---|
| API 4380 G HV3 | Field configurable Specify input range if factory is to set switches | Field configurable Specify output range if factory is to set switches | 115 VAC  |
| API 4380 G HV3 A230 | | | 230 VAC  |
| API 4380 G HV3 P | | | 85-265 VAC or 60-300 VDC |
| API 4380 G HV3 D | | | 9-30 VDC |

Free Factory Setup

Specify I/O ranges if factory is to set switches

Options—add to end of model number

- DF** 30 millisecond response time, or consult factory
 DF option will cause output noise levels greater than standard specifications.
- U** Conformal coating for moisture resistance

Accessories—order as separate line item

- API 008** 8-pin socket
- API 008 FS** 8-pin finger-safe socket
- API CLP1** Module hold-down spring for high vibration or mobile applications



Precautions

WARNING! All wiring must be performed by a qualified electrician or instrumentation engineer. See diagram for terminal designations and wiring examples. Consult factory for assistance.

WARNING! Avoid shock hazards! Turn signal input, output, and power off before connecting or disconnecting wiring, or removing or installing module.

Précautions

ATTENTION! Tout le câblage doit être effectué par un électricien ou ingénieur en instrumentation qualifié. Voir le diagramme pour désignations des bornes et des exemples de câblage. Consulter l'usine pour assistance.

ATTENTION! Éviter les risques de choc! Fermez le signal d'entrée, le signal de sortie et l'alimentation électrique avant de connecter ou de déconnecter le câblage, ou de retirer ou d'installer le module.

API maintains a constant effort to upgrade and improve its products. Specifications are subject to change without notice. See api-usa.com for latest product information. Consult factory for your specific requirements.

WARNING: This product can expose you to chemicals including lead, which is known to the State of California to cause cancer or birth defects or other reproductive harm. For more information go to www.P65Warnings.ca.gov

Socket and Mounting

Install module in a protective panel or enclosure. Allow space around module for air flow. Use API 008 or API 008 FS socket. See specifications for maximum allowable socket voltages. The socket clips to a standard 35 mm DIN rail or can be mounted to a flat surface.

Range Selection

Two slide switches and three rotary switches located on the side of the module are used to select input and output ranges. Most popular ranges are listed on the module label. See table below. Special ranges will be indicated on the model/serial number module label.

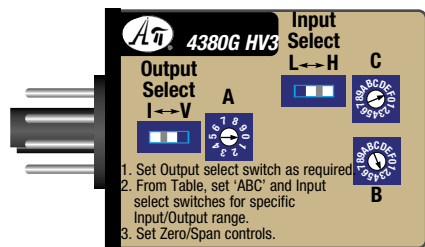

1. Unplug the module from its socket. Do not change ranges while the module is powered.
2. Locate the switch combination for your desired input and output ranges from the table.
3. Set the OUTPUT SELECT slide switch to current (I) or voltage (V) depending on output type.
4. Set the three rotary switches A, B, and C to the values found in the table.
5. Set the INPUT SELECT slide switch to L or H depending on table value.

6. Proceed to Calibration and Output Test Function setup. The Zero, Span and Test Range potentiometers can now be adjusted for the desired output range.

Depending on the rotary switch settings, the input is filtered, either amplified or attenuated as required, then passed through an optical isolation circuit to the output stage.

The input selector switch determines the input impedance for the module, typically 50 Ω for current inputs and 1 MΩ or greater for voltage inputs.

Signal Output

Polarity must be observed when connecting the signal output to the load. The module provides 20 VDC power to the output loop when current output is selected.

Signal Input

For safety, input must be off while connecting wiring. Connect the signal input to terminals 5 and 6.

Module Power

Check model/serial number label for module operating voltage to make sure it matches available power.

AC power is connected to terminals 1 and 3.

For DC powered modules, polarity MUST be observed.

Positive (+) is wired to terminal 1

Negative (-) is wired to terminal 3

Calibration

Input and output ranges if specified on your order are factory pre-configured (at 24°C ±1°C). Top-mounted Zero and Span potentiometers calibrate the output.

Note: Perform the following calibration procedure any time switch settings are changed.

1. Apply power to the module and allow a minimum 20 minute warm up time.
2. Using an accurate calibration source, provide an input to the module equal to the minimum input required for the application.
3. Using an accurate measurement device for the output, adjust the Zero potentiometer for the exact minimum output desired. The Zero control should only be adjusted when the input signal is at its minimum. This will produce the corresponding minimum output signal. For example: 4 mA for a 4-20 mA output or -10 V for a ±10V output.
4. Next, set the input at maximum, then adjust the Span pot for the exact maximum output desired. The Span control should only be adjusted when the input signal is at its maximum. This will produce the corresponding maximum output signal. Example: for 4-20 mA output, the Span control will provide adjustment for the 20 mA or high end of the signal.
5. Repeat adjustments for maximum accuracy.

Output Test Function

The Test button may be pushed to provide a fixed output when depressed. This will drive the device on the output side of the loop (a panel meter, chart recorder, etc.) with a known good signal that can be used as a system diagnostic aid during initial start-up or during troubleshooting.

It can be adjusted to vary the output signal from 0 to 100% of the calibrated output range. When released, the output will return to normal. Turn the multi-turn Test Range potentiometer while holding the Test Switch depressed until the desired output test level is reached.

Operation

The API 4380 G HV3 input is filtered, either amplified or attenuated as required, then passed through an optical isolation circuit to the output stage.

The green LoopTracker® input LED provides a visual indication that a signal is being sensed by the input circuitry of the module. It also indicates the input signal strength by changing in intensity as the process changes from minimum to maximum.

If the LED fails to illuminate, or fails to change in intensity as the process changes, check the module power or signal input wiring. Note that it may be difficult to see the LEDs under bright lighting conditions.

The red LoopTracker output LED provides a visual indication that the output signal is functioning. It becomes brighter as the input and the corresponding output change from minimum to maximum.

For a current output, the red LED will only light if the output loop current path is complete. For either current or voltage outputs, failure to illuminate or a failure to change in intensity as the process changes may indicate a problem with the module power or signal output wiring.

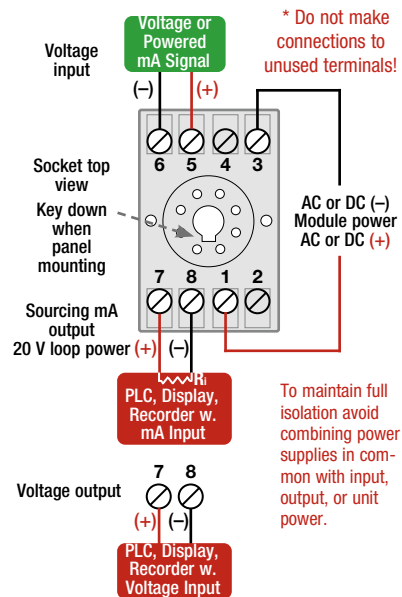

| Output | 0-1 V | 0-2 V | 0-4 V | 0-5 V | 1-5 V | 0-8 V | 2-10 V | 0-10 V | ±5 V | ±10 V | 0-2 mA | 0-10 mA | 2-10 mA | 0-16 mA | 4-20 mA | 0-20 mA |
|----------|--------|--------|--------|--------|--------|--------|--------|--------|--------|--------|--------|---------|---------|---------|---------|---------|
| Switches | ABC IO | ABC IO | ABC IO | ABC IO | ABC IO | ABC IO | ABC IO | ABC IO | ABC IO | ABC IO | ABC IO | ABC IO | ABC IO | ABC IO | ABC IO | ABC IO |
| 0-1 V | 081HV | 181HV | 281HV | 381HV | 283HV | 581HV | 583HV | 681HV | 881HV | 981HV | 081HI | 381HI | 283HI | 581HI | 583HI | 681HI |
| 0-2 V | 091HV | 191HV | 291HV | 391HV | 293HV | 591HV | 593HV | 691HV | 891HV | 991HV | 091HI | 391HI | 293HI | 591HI | 593HI | 691HI |
| 0-3 V | 0A1LV | 1A1LV | 2A1LV | 3A1LV | 2A3LV | 5A1LV | 5A3LV | 6A1LV | 8A1LV | 9A1LV | 0A1LI | 3A1LI | 2A3LI | 5A1LI | 5A3LI | 6A1LI |
| 0-4 V | 0A1HV | 1A1HV | 2A1HV | 3A1HV | 2A3HV | 5A1HV | 5A3HV | 6A1HV | 8A1HV | 9A1HV | 0A1HI | 3A1HI | 2A3HI | 5A1HI | 5A3HI | 6A1HI |
| 0-5 V | 0C1HV | 1C1HV | 2C1HV | 3C1HV | 2C3HV | 5C1HV | 5C3HV | 6C1HV | 8C1HV | 9C1HV | 0C1HI | 3C1HI | 2C3HI | 5C1HI | 5C3HI | 6C1HI |
| 0-8 V | 0B1HV | 1B1HV | 2B1HV | 3B1HV | 2B3HV | 5B1HV | 5B3HV | 6B1HV | 8B1HV | 9B1HV | 0B1HI | 3B1HI | 2B3HI | 5B1HI | 5B3HI | 6B1HI |
| 0-10 V | 001HV | 101HV | 201HV | 301HV | 203HV | 501HV | 503HV | 601HV | 801HV | 901HV | 001HI | 301HI | 203HI | 501HI | 503HI | 601HI |
| 0-15 V | 011LV | 111LV | 211LV | 311LV | 213LV | 511LV | 513LV | 611LV | 811LV | 911LV | 011LI | 311LI | 213LI | 511LI | 513LI | 611LI |
| 0-20 V | 011HV | 111HV | 211HV | 311HV | 213HV | 511HV | 513HV | 611HV | 811HV | 911HV | 011HI | 311HI | 213HI | 511HI | 513HI | 611HI |
| 0-30 V | 021LV | 121LV | 221LV | 321LV | 223LV | 521LV | 523LV | 621LV | 821LV | 921LV | 021LI | 321LI | 223LI | 521LI | 523LI | 621LI |
| 0-40 V | 021HV | 121HV | 221HV | 321HV | 223HV | 521HV | 523HV | 621HV | 821HV | 921HV | 021HI | 321HI | 223HI | 521HI | 523HI | 621HI |
| 0-50 V | 041HV | 141HV | 241HV | 341HV | 243HV | 541HV | 543HV | 641HV | 841HV | 941HV | 041HI | 341HI | 243HI | 541HI | 543HI | 641HI |
| 0-60 V | 031LV | 131LV | 231LV | 331LV | 233LV | 531LV | 533LV | 631LV | 831LV | 931LV | 031LI | 331LI | 233LI | 531LI | 533LI | 631LI |
| 0-75 V | 051LV | 151LV | 251LV | 351LV | 253LV | 551LV | 553LV | 651LV | 851LV | 951LV | 051LI | 351LI | 253LI | 551LI | 553LI | 651LI |
| 0-80 V | 031HV | 131HV | 231HV | 331HV | 233HV | 531HV | 533HV | 631HV | 831HV | 931HV | 031HI | 331HI | 233HI | 531HI | 533HI | 631HI |
| 20-100 V | 03FHV | 13FHV | 23FHV | 33FHV | 231HV | 53FHV | 531HV | 63FHV | 83FHV | 93FHV | 03FHI | 33FHI | 231HI | 53FHI | 531HI | 63FHI |
| 0-100 V | 051HV | 151HV | 251HV | 351HV | 253HV | 551HV | 553HV | 651HV | 851HV | 951HV | 051HI | 351HI | 253HI | 551HI | 553HI | 651HI |
| 0-150 V | 061LV | 161LV | 261LV | 361LV | 263LV | 561LV | 563LV | 661LV | 861LV | 961LV | 061LI | 361LI | 263LI | 561LI | 563LI | 661LI |
| 0-200 V | 061HV | 161HV | 261HV | 361HV | 263HV | 561HV | 563HV | 661HV | 861HV | 961HV | 061HI | 361HI | 263HI | 561HI | 563HI | 661HI |
| ±75 V | 064LV | 164LV | 264LV | 364LV | 266LV | 564LV | 566LV | 664LV | 864LV | 964LV | 064LI | 364LI | 266LI | 564LI | 566LI | 664LI |
| ±100 V | 064HV | 164HV | 264HV | 364HV | 266HV | 564HV | 566HV | 664HV | 864HV | 964HV | 064HI | 364HI | 266HI | 564HI | 566HI | 664HI |
| ±150 V | 074LV | 174LV | 274LV | 374LV | 276LV | 5743V | 576LV | 674LV | 874LV | 974LV | 074LI | 374LI | 276LI | 574LI | 576LI | 674LI |
| ±200 V | 074HV | 174HV | 274HV | 374HV | 276HV | 574HV | 576HV | 674HV | 874HV | 974HV | 074HI | 374HI | 276HI | 574HI | 576HI | 674HI |