



*APLUS*  
**Measurement, monitoring and  
power quality analysis in  
power systems**

## Fields of application

The *APLUS* is a comprehensive instrument for the universal measurement, monitoring and power quality analysis in power systems. The focus is on highest Swiss quality and maximum customer benefit.

The device is suited for the application in power distribution, in strongly distorted industrial environments and in building automation. Nominal voltages up to 690 V can directly be connected.

The connection of the process environment may be performed by means of the communication interface, via digital I/Os or via analog outputs.

## Possible applications in power systems

- Acquisition and control of the present system state
- Monitoring of the operational behaviour
- Analysis of the power quality
- Determining load profiles and energy demand values
- Finding the variations of the system load
- Measurement before and behind frequency converters
- Recording of operating procedures

## Measurement of power quantities.

The *APLUS* can be adapted fast and easily to the measurement task by means of the CB-Manager software. The universal measurement system of the device may be used directly for any system, from single phase up to 4-wire unbalanced networks, without hardware modifications. Independent of measurement task and outer influences always the same high performance is achieved.

The measurement is performed in all four quadrants and can be adapted to the system to monitor in an optimal way. The measurement time as well as the expected system load can be parameterized.

Measured quantity	Measurement uncertainty
Voltage, current	± 0.1%
Power, imbalance	± 0.2%
Harmonics, THD, TDD	± 0.5%
Frequency	± 0.01Hz
Load factor	± 0.1°
Energy	± 0.2% (Full scale)
– active energy	Class 0.5S (EN 62053-22)
– reactive energy	Class 2 (EN 62053-23)

## Monitoring the operational behaviour.

To effectively protect operating resources it must be assured that multiple system quantities are within their allowed range. The logic module offers a comfortable facility to combine multiple limit values and to trigger further actions such as alarming, event registration or disturbance recording.

To monitor the operating time of specific loads up to three operating time counters are supported, which are controlled by means of limit values or digital operating feedbacks. One more operating time counter determines the time the *APLUS* itself has been switched on.

## Possible applications of the logic module are:

- Function of protective relays (e.g. over-current, phase failure or imbalance)
- Changeover of the present operating mode, such as local/remote (day/night) operation
- Controlling the recording of alarms, events and acknowledgment procedures
- Monitoring of external devices: circuit states or self monitoring signals

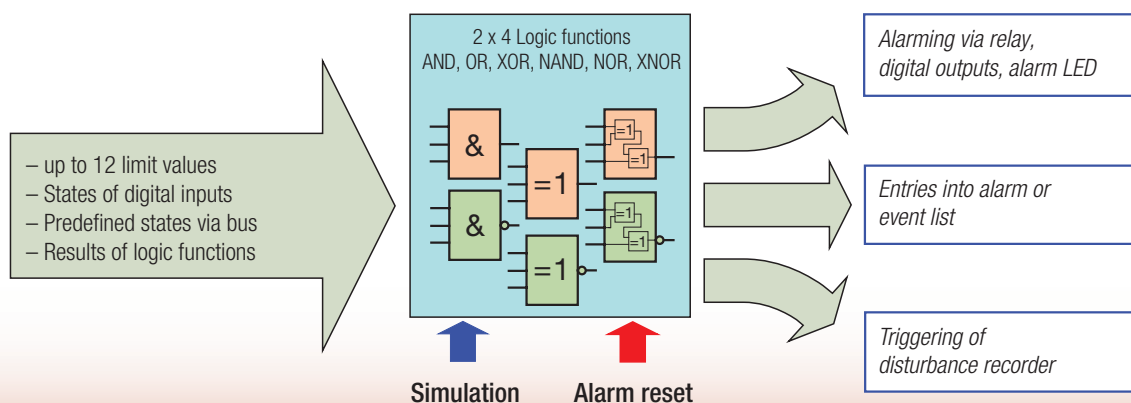

# Power quality analysis instead of failure analysis.

In the world of standards the quality of a grid is defined using statistical deviations from a desired standard behaviour. But what's really needed when monitoring power quality is a statement if the used operating resources will work undisturbed under the real existing conditions.

The *APLUS* therefore does not work with statistics, but examines the real environment, to allow performing a corresponding immunity analysis. Almost all important aspects of power quality can be investigated and interpreted.

## Variation of the system load

The absolute minimum/maximum values with timestamp are available for instantaneous and mean values. They indicate the bandwidth of the variations of the system parameters.

Using the extreme value data logger also short-term variations within an interval can be acquired. This way e.g. a load profile can be recorded, where along with the mean power also the highest and lowest short-term demand will be shown.

## Additional load by harmonics

Harmonics originate from non-linear loads in the grid - a homemade pollution most of the time. They may induce an additional thermal stress to operational resources or wires and disturb the operation of sensitive loads.

The *APLUS* shows the harmonic contents of currents as Total Demand Distortion, briefly TDD. This value is scaled to the rated current resp. rated power. Only this way its influence on the connected equipment can be estimated correctly. In industrial grids the image of the harmonics often allows to determine quite good what types of loads are connected to the system.

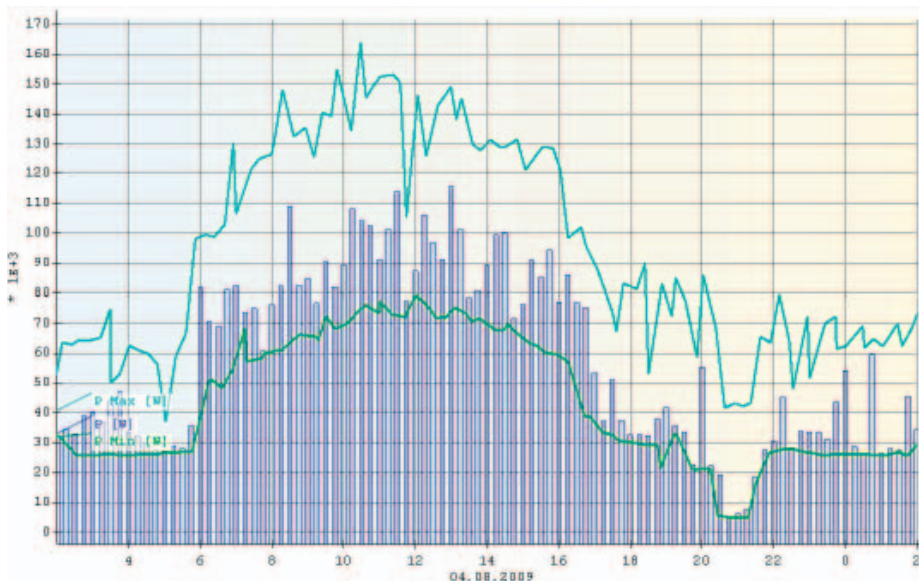
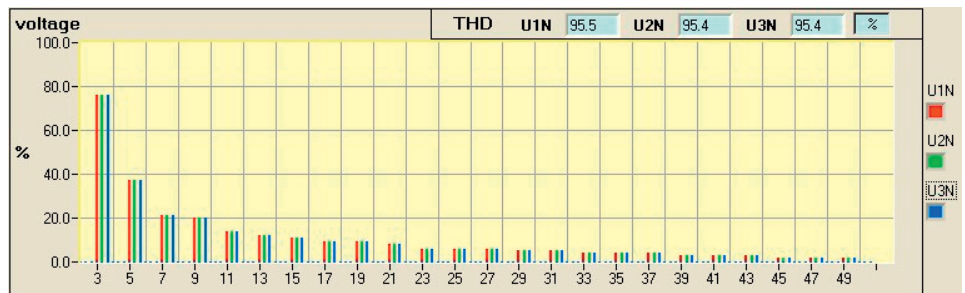

*Hint: The accuracy of the harmonic analysis depends strongly on the quality of the current and voltage transformers possibly used, because harmonics are normally heavily distorted. It's valid: The higher the frequency of the harmonic, the higher its damping.*

## Violations of limit values

Important parameters, such as imbalance, should be checked continuously to protect important operating resources, by separating them from the grid in better time.

In association with the data logger violations of limit values may be recorded with the time of their occurrences.

## System imbalance

System imbalance not only occurs due to single phase load situations, but is often a sign for disturbances in the grid, such as isolation failure, phase failure or earth-leakage. Three phase loads are often very sensitive to operating voltages provided imbalanced. This may lead to a shorter lifetime or even damage.

An imbalance monitoring therefore not only helps to save costs in maintenance but also prolongs the undisturbed operating time of the used production facilities.

## Fundamental and distortion reactive power

The reactive power may be divided in a fundamental and a distortion component. Only the fundamental reactive power may be compensated using the classical capacitive method. The distortion component, which originate from harmonic currents, have to be combated using inductors or active harmonic conditioners.

Rectifiers, inverters and frequency converters are only a few examples of components generating distortion reactive power. But normally only in industrial grids it may represent a real problem.

## THE DISPLAY



The APLUS offers all which is requested from a device with display:

- Excellent legibility from almost any distance and each angle
- Clear and explicit display of measured data
- Free composition of measurement displays
- Free allocation of alarms to status LED's
- Free definable plaintext display for alarming
- Preference display and roll mode

## DISPLAY MODES

**FULL:** All measurement displays in a matrix representation, selected via arrow keys. Fourth line used for meter display.

**REDUCED:** Same as FULL mode but with facility to hide individual measurement displays.

**USER:** Up to 20 free composable measurement displays, selected with  and . The fourth line may be used to display meter contents or system quantities (P,Q,S,U,I).

**LOOP:** Measurement displays of the USER mode will be displayed successively for a definable time.

## PROGRAMMING

On the device ratios of current and voltage transformers, parameters of the communication interface, threshold values of limit value, time and date as well as display settings can be modified.

Selectively per measurement group the registered min/max or meter values may be reset.

## ALARMS+METERS

The occurrence of an alarm state can be signaled via the yellow LED's. The corresponding alarm text will be displayed by shortly pres-

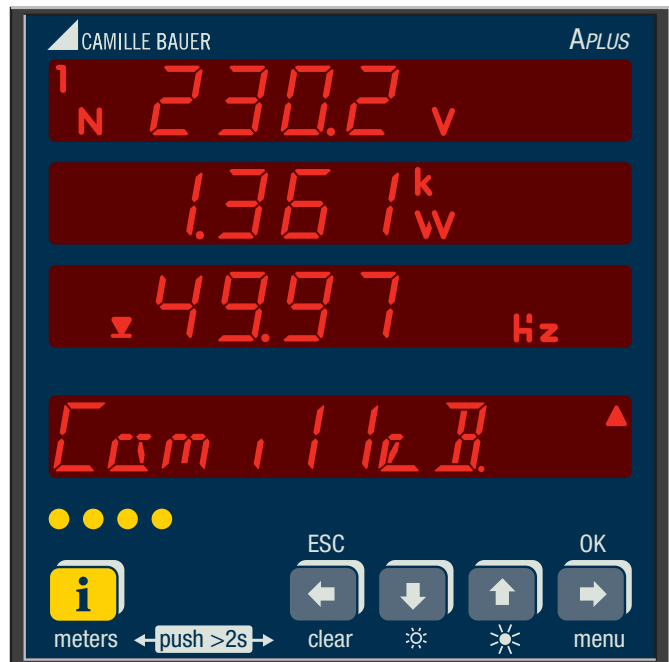

sing . At the same time instead of the measured quantities their identification is shown for a second.

For reading the 8-digit meter contents the key  must be pressed longer than 2 seconds. Using  and  you may scroll through all the values.

## SECURITY SYSTEM

All programming functions may be locked selectively by means of the PC software. They then are not at the user's disposal when operating the display unit.

Also for the access via interface the alteration of device data may be granted or locked per group.

## Parametrization, service and measurement acquisition

The supplied CB-Manager software provides the following functions to the user:

- Complete parametrization of the APLUS (also offline)
- Acquisition and recording of measured quantities
- Archiving of configuration and measurement files
- Setting or resetting of meter contents
- Selective reset of extreme values
- Setting of interface parameters
- Simulation of logic module or outputs functions
- Comprehensive help system

A security system can be activated to restrict the access to device data. This way e.g. changing a limit value via display can be locked, but a setting via configuration could still be possible.

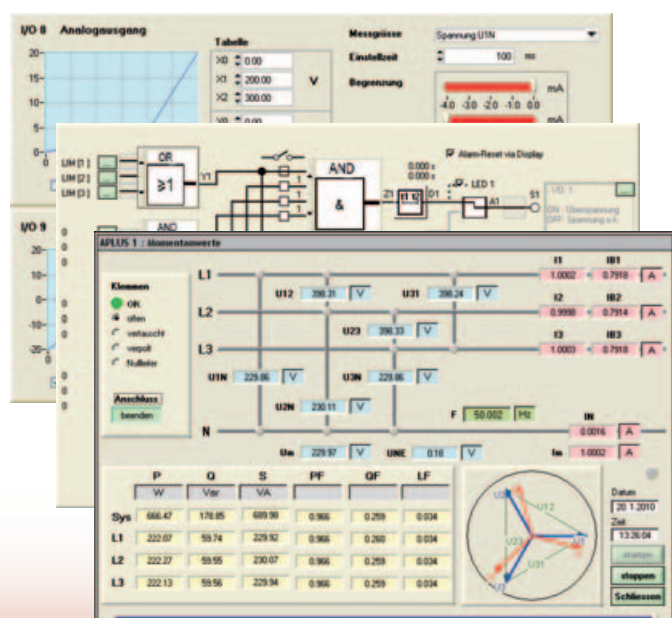

## Free composition of the required functions

The *APLUS* basic unit is already comprehensively equipped with a relay output for alarming, a digital output, e.g. for pulse output, and a digital input, e.g. for tariff switching.

For applications where this is not sufficient, the optional I/O extensions 1 or 2 are available (see graphic).

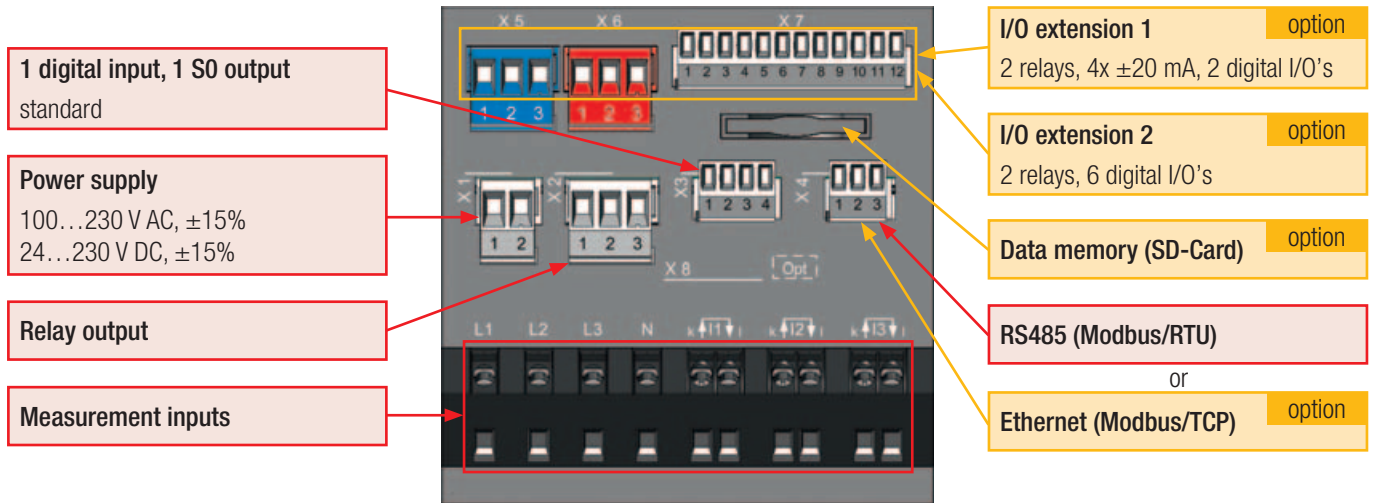

### Possible applications of the I/Os

#### Relay outputs

- Alarming via lamp or horn
- Load shedding
- Self monitoring signal of *APLUS* (via relay of basic unit)
- Remote controllable via bus interface

#### Digital outputs <sup>1)</sup>

- Alarm output of the logic module
- State reporting
- Pulse output to external counters (acc. EN62053-31)
- Remote controllable via bus interface

<sup>1)</sup> The digital I/O's of the I/O extensions can individually be configured for input or output.

#### Analog outputs

- Connection to PLC or another measurement system (e.g. CAM)
- All outputs are bipolar (±20 mA) and galvanically isolated.

#### Digital inputs <sup>1)</sup>

- Meter tariff switching
- Operating feedback of loads for operating time counters
- Trigger and release signal for logic module
- Pulse input for any meters
- Clock synchronization
- Synchronization of billing intervals

## Order code *APLUS* - . . . . .

<b>1. Basic unit <i>APLUS</i></b> With LED display, for panel mounting	1
<b>2. Input frequency range</b> 45...50/60...65 Hz	1
<b>3. Auxiliary power supply</b> Nominal voltage 24...230 V DC, 100...230 V AC	1
<b>4. Communication interface</b> RS485, Protocol Modbus/RTU	1
Ethernet, Protocol Modbus/TCP, NTP <sup>2)</sup>	2
<b>5. I/O extension</b> Without	0
2 relays, 4 analog outputs ±20 mA, 2 digital I/O's	1
2 relays, 6 digital I/O's	2

<b>6. Test certificate</b> Without	0
Test certificate in German	D
Test certificate in English	E
<b>7. Data logger</b> Without data logger	0
With data logger <sup>2)</sup>	1

Accessories	Order no.
Interface converter USB <> RS485	163 189
Connection set: Plug-in terminals, mounting clamps <sup>3)</sup>	168 220
Plug-in terminals I/O extension <sup>3)</sup>	168 232

<sup>2)</sup> Available as from 07-2010    <sup>3)</sup> scope of supply

## Technical data

### Inputs

<b>Nominal current:</b>	adjustable 1...5 A
Maximum:	7.5 A (sinusoidal)
Consumption:	$\leq P^2 \times 0.01 \Omega$ per phase
Overload capability:	10 A continuous 100 A, 10 x 1 s, interval 100 s
<b>Nominal voltage:</b>	57.7...400 V <sub>LN</sub> , 100...693 V <sub>LL</sub>
Maximum:	480 V <sub>LN</sub> , 832 V <sub>LL</sub> (sinusoidal)
Consumption:	$\leq U^2 / 3 M\Omega$ per phase
Impedance:	3 M $\Omega$ per phase
Overload capability:	480 V <sub>LN</sub> , 832 V <sub>LL</sub> continuous 600 V <sub>LN</sub> , 1040 V <sub>LL</sub> , 10 x 10 s, interval 10 s 800 V <sub>LN</sub> , 1386 V <sub>LL</sub> , 10 x 1 s, interval 10 s
<b>Systems:</b>	Single phase Split phase (2 phase system) 3-wire, balanced load 3-wire, unbalanced load 3-wire, unbalanced load, Aron connection 4-wire, balanced load 4-wire, unbalanced load 4-wire, unbalanced load, Open-Y
Nominal frequency:	45... 50 / 60 ...65 Hz
Measurement TRMS:	up to 63rd harmonic

### Measurement uncertainty

<i>Reference conditions:</i>	<i>Ambient 15...30°C, sinusoidal, measurement over 8 cycles, PF=1, frequency 50...60 Hz</i>
<i>(acc. IEC/EN 60688)</i>	
Voltage, current:	$\pm (0.08\% MV + 0.02\% MR)$ <sup>1) 2)</sup>
Power:	$\pm (0.16\% MV + 0.04\% MR)$ <sup>3) 2)</sup>
Power factor:	$\pm 0.1^\circ$ <sup>4)</sup>
Frequency:	$\pm 0.01$ Hz
Imbalance U <sub>L</sub> I:	$\pm 0.5\%$
Harmonics:	$\pm 0.5\%$
THD voltage:	$\pm 0.5\%$
TDD current:	$\pm 0.5\%$
Active energy:	Class 0.5S, EN 62 053-22
Reactive energy:	Class 2, EN 62 053-23
<b>Power supply:</b>	via plug-in terminals
Nominal voltage:	100...230 V AC $\pm 15\%$ , 50...400 Hz 24...230 V DC $\pm 15\%$
Consumption:	$\leq 7$ VA

### I/O-Interface

<b>Basic device:</b>	1 relay output, changeover contact 1 digital output (fixed) 1 digital input (fixed)	<b>Relays:</b>	via plug-in terminals
<b>I/O extension 1:</b>	2 relay outputs, changeover contact 4 bipolar analog outputs 2 digital inputs/outputs	Contacts:	changeover contact, bistabil
<b>I/O extension 2:</b>	2 relay outputs, changeover contact 6 digital inputs/outputs	Load capacity:	250 V AC, 2 A, 500 VA 30 V DC, 2 A, 60 W
<b>Analog outputs:</b>	via plug-in terminals, galvanically isolated	<b>Digital inputs / outputs</b>	Connection via plug-in terminals. For I/O extension individually configurable as input or output.
Linearization:	Linear, quadratic, kinked	<i>Inputs (acc. EN 61 131-2 DC 24 V Type 3):</i>	
Range:	$\pm 20$ mA (24 mA max.), bipolar	Nominal voltage	12 / 24 V DC (30 V max.)
Uncertainty:	$\pm 0.2\%$ of 20 mA	Logical ZERO	- 3 up to + 5 V
Burden:	$\leq 500 \Omega$ (max. 10 V / 20 mA)	Logical ONE	8 up to 30 V
Burden influence:	$\leq 0.2\%$	<i>Outputs (partly acc. EN 61 131-2):</i>	
Residual ripple:	$\leq 0.4\%$	Nominal voltage	12 / 24 V DC (30 V max.)
		Nominal current	50 mA (60 mA max.)
		Load capability	400 $\Omega$ ... 1 M $\Omega$

### Interface

<b>Modbus/RTU</b>	via plug-in terminals	Baud rate:	2.4 up to 115.2 kBaud
Protocol:	Modbus RTU	Number of participants:	$\leq 32$
Physics:	RS-485, max. 1200 m (4000 ft)		

### Internal clock (RTC)

Uncertainty:	$\pm 2$ minutes / month (15 up to 30°C), trimmable via PC software	Synchronization:	via synchronization pulse
		Running reserve:	> 10 years

<sup>1)</sup> MV: measured value, MR: measurement range (maximum)

<sup>2)</sup> Additional uncertainty for voltage measurement of 0.1% MV if neutral wire not connected (3-wire connections)

<sup>3)</sup> MR: maximum voltage x maximum current

<sup>4)</sup> Additional uncertainty of 0.1° if neutral wire not connected (3-wire connections)

## Disposable measured quantities

### Basic measured quantities

These measured quantities are determined using the configured measurement time (2...1024 cycles, in steps of 2 cycles). The display refreshment takes place with the refresh rate set.

Measured quantity	present	max	min
Voltage per phase, system	•	•	•
Mean value of voltages $U_{\text{mean}}$	•		
Zero displacement voltage $U_{\text{NE}}$	•	•	
Maximum $\Delta U <> U_{\text{mean}}^1$	•	•	•
Phase angle of voltages	•		
Current per phase, system	•	•	
Mean value of phase currents	•		
Neutral current $I_{\text{N}}$	•	•	
Maximum $\Delta I <> I_{\text{mean}}^2$	•	•	

Measured quantity	present	max	min
Bimetal current per phase, system	•	•	
Active power per phase, system	•	•	
Reactive power per phase, system	•	•	
Apparent power per phase, system	•	•	
Frequency	•	•	•
Power factor per phase, system	•	•	
Power factor per quadrant			•
Reactive power factor per phase, system	•		
LF factor per phase, system	•		

### Power quality analysis

These values are calculated about twice a second, depending on the system frequency.

Measured quantity	present	max	min
Harmonic analysis			
THD voltage per phase	•	•	
TDD current per phase	•	•	
Harmonics voltage 2nd – 50th per phase	•	•	
Harmonics current 2nd – 50th per phase	•	•	
Distortion reactive power per phase, system	•	•	
Fundamental reactive power per phase, system	•	•	
$\cos\phi$ fundamental per phase, system	•		•

Measured quantity	present	max	min
Imbalance currents / voltages			
Symmetrical components [V]	•		
Symmetrical components [A]	•		
Imbalance voltage: negative/positive sequence	•	•	
Imbalance voltage: zero/positive sequence <sup>4)</sup>	•	•	
Imbalance current: negative/positive sequence	•		
Imbalance current: zero/positive sequence <sup>4)</sup>	•	•	

### Meters

Measured quantity	present	HT	LT
Active energy incoming: per phase, system	•	•	•
Active energy outgoing system	•	•	•
Reactive energy incoming: per phase, system	•	•	•

Measured quantity	present	HT	LT
Reactive energy outgoing system	•	•	•
Reactive energy inductive, capacitive system	•	•	•
I/O meters 1...7 <sup>3)</sup>	•	•	•

### Mean-values

As a standard the mean-values of the system power quantities are determined over the same programmable interval time  $t_1$ . The interval time  $t_2$  of the selectable mean-value quantities may be different but equal for all 12 quantities.

Measured quantity	present	trend	max	min	history
Active power incoming 1 s...60 min	•	•	•	•	5
Active power outgoing 1 s...60 min	•	•	•	•	5
Reactive power incoming 1 s...60 min	•	•	•	•	5
Reactive power outgoing 1 s...60 min	•	•	•	•	5

Measured quantity	present	trend	max	min	history
Reactive power induct. 1 s...60 min	•	•	•	•	5
Reactive power capac. 1 s...60 min	•	•	•	•	5
Apparent power 1 s...60 min	•	•	•	•	5
Mean-value quant. 1-12 1 s...60 min <sup>4)</sup>	•	•	•	•	1

1) Maximum deviation from the mean-value of the 3 phase voltages

2) Maximum deviation from the mean-value of the 3 phase currents

3) Possible meters of the digital pulse inputs – any measurand and unit

4) Available via communication interface only, no indication on display

## Ambient conditions, general information

Operating temperature: -10 ... 15 ... 30 ... + 55°C  
 Storage temperature: -25 up to + 70 °C  
 Temperature influence: 0.5 x basic uncertainty per 10 K  
 Long term drift: 0.2 x basic uncertainty per year

Others: Usage group II (EN 60 688)  
 Relative humidity: < 95% no condensation  
 Altitude: ≤ 2000 m max.  
 Device to be used indoor only!

## Mechanical attributes

Orientation: Any  
 Housing material: Polycarbonat (Makrolon)  
 Flammability class: V-0 acc. UL94, self-extinguishing, non-dripping, free of halogen  
 Weight: 500 g

### Panel cut-out

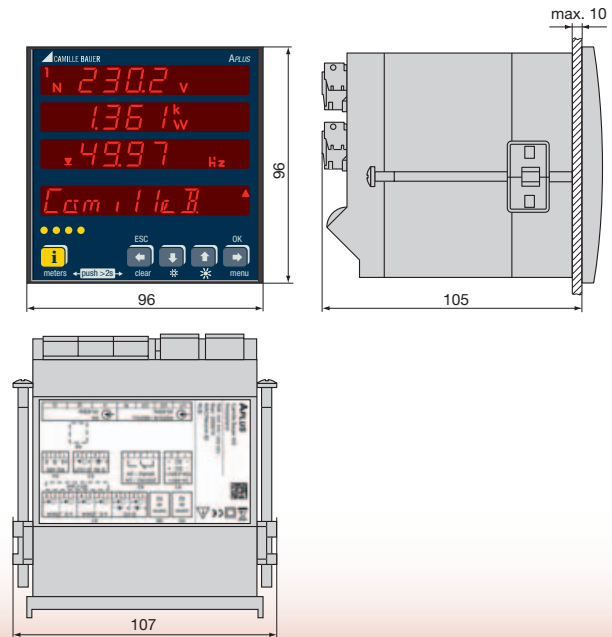
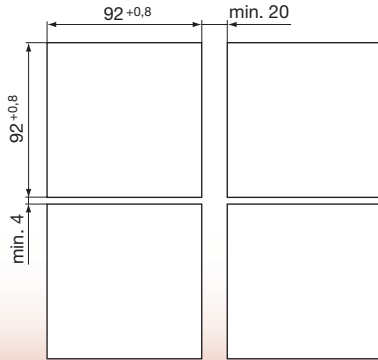

## Safety

The current inputs are galvanically isolated from each other.  
 Protection class: II (protective insulation, voltage inputs via protective impedance)  
 Pollution degree: 2

Protection rating: IP64 (front), IP40 (housing), IP20 (terminals)  
 Measurement category: CAT III, CATII (relays)

## Applied standards, regulations and directives

IEC/EN 61 010-1	Safety regulations for electric measuring, control and laboratory equipment	IEC/EN 61 000-6-2/ 61 000-6-4:	Electromagnetical compatibility (EMC) Generic standards for industrial environment
IEC/EN 60 688	Electrical measuring transducers for converting AC electrical variables into analog or digital signals	IEC/EN 61 131-2	Programmable controllers – equipment, requirements and tests (digital inputs/outputs 12/24V DC)
DIN 40 110	AC quantities	IEC/EN 61 326	Electrical equipment for measurement, control and laboratory use – EMC requirements
IEC/EN 60 068-2-1/ -2/-3/-6/-27:	Ambient tests -1 Cold, -2 Dry heat, -3 Damp heat, -6 Vibration, -27 Shock	IEC/EN 62 053-31	Pulse output devices for electromechanical and electronic meters (SO output)
IEC/EN 60 529	Protection type by case	UL94	Test for flammability of plastic materials for parts in devices and appliances
2002/95/EG (RoHS)	EC directive on the restriction of the use of certain hazardous substances		



**Rely on us.**

Camille Bauer AG  
 Aargauerstrasse 7  
 CH-5610 Wohlen / Switzerland  
 Phone: +41 56 618 21 11  
 Fax: +41 56 618 35 35  
 info@camillebauer.com  
 www.camillebauer.com